



The order number consists of the profile number and the desired length (max. length 6000 mm), e.g. S 22/2500 (= 2500 mm). The price of a profile includes cutting.

El número de referencia de los perfiles se compone de la denominación y del largo deseado (largo máx.6000 mm), p.ej.: S 22/2500 (=2500 mm). El corte del perfil esta incluido en el precio.

Aluminium profiles Perfiles en aluminio

1.1	Standard upright profiles	Perfiles verticales estándar
1.3	Smooth upright profiles	Perfiles verticales lisos
1.4	Special upright profiles	Perfiles verticales especiales
1.8	Round upright profiles	Perfiles verticales redondos
1.11	Crossbeam profiles	Perfiles horizontales
1.14	Space-Line profiles	Perfiles Space-Line
1.17	Future-Line profiles	Perfiles Future-Line
1.19	Sliding door profiles	Perfiles para puertas correderas
1.20	Supplementary profiles	Perfiles complementarios de aluminio

1.1 - 1.23

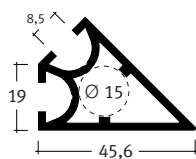
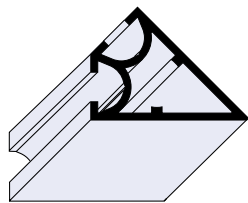

S 22

Upright profile Perfil vertical

max. length 6 m
Accessories:
Insert AVR 22
Alu-foot VR 10

max. 6 m de largo,
accesorios:
acoplamiento AVR 22
para base regulable
VR 10

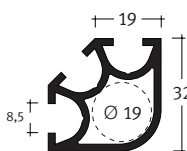
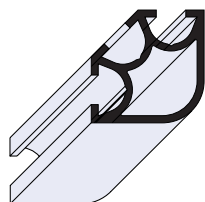

S 30

Upright profile Perfil vertical

max. length 6 m
Accessories:
Insert AVR 30
Alu-foot VR 10

max. 6 m de largo,
accesorios:
acoplamiento AVR 30
para base regulable
VR 10

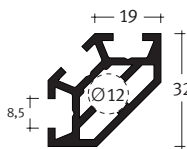
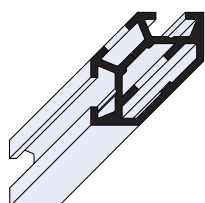

S 38

Upright profile Perfil vertical

max. length 6 m
Accessories:
Insert AVR 38
Alu-foot VR 8

max. 6 m de largo,
accesorios:
acoplamiento AVR 38
para base regulable
VR 8

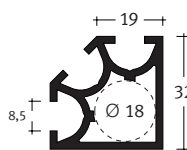
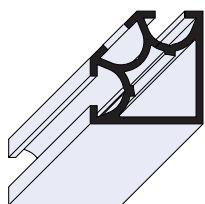

S 39

Upright profile Perfil vertical

max. length 6 m
Accessories:
Insert AVR 39
Alu-foot VR 10

max. 6 m de largo,
accesorios:
acoplamiento AVR 39
para base regulable
VR 10

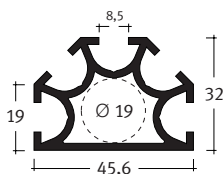
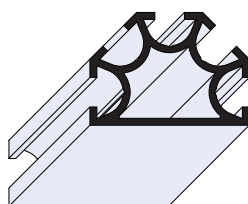

S 50

Upright profile Perfil vertical

max. length 6 m
Accessories:
Insert AVR 50
Alu-foot VR 10
Lock adapter FIX 43

max. 6 m de largo,
accesorios:
acoplamiento AVR 50
para base regulable
VR 10, grappa FIX 43

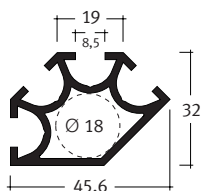
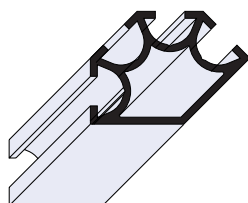

S 51

Upright profile Perfil vertical

max. length 6 m
Accessories:
Insert AVR 51
Alu-foot VR 10

max. 6 m de largo,
accesorios:
acoplamiento AVR 51
para base regulable
VR 10

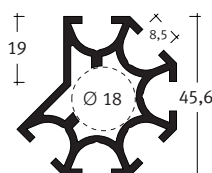
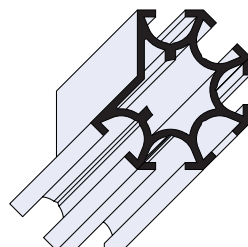

S 52

Upright profile Perfil vertical

max. length 6 m
Accessories:
Insert AVR 52
Alu-foot VR 10

max. 6 m de largo,
accesorios:
acoplamiento AVR 52
para base regulable
VR 10

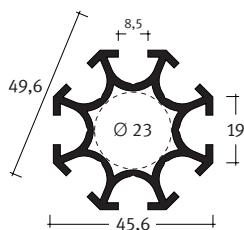
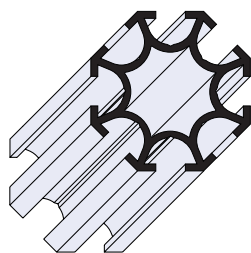

S 80

Upright profile Perfil vertical

max. length 6 m
Accessories:
Insert AVR 80
Alu-foot VR 10

max. 6 m de largo,
accesorios:
acoplamiento AVR 80
para base regulable
VR 10

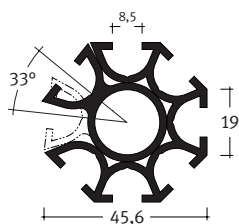
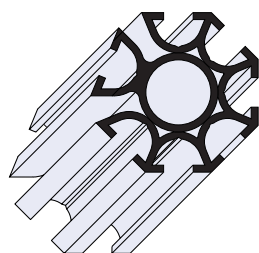

S 88/K

Upright profile Perfil vertical

complete profile,
combination of
S 88/1 and S 88/2
max. length 6 m
Accessories:
Insert AVR 88
Alu-foot VR 10

con anguló variable
compuesto de S 88/1
y S 88/2
max. 6 m de largo,
accesorios:
acoplamiento AVR 88
para base regulable
VR 10

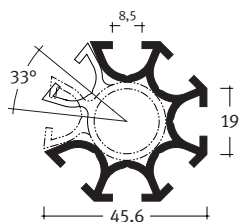
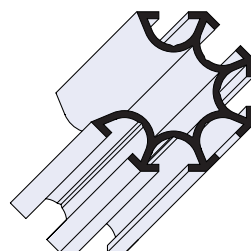

S 88/1

Upright profile Perfil vertical

outside shell
max. length 6 m
Accessories:
Insert AVR 88
Alu-foot VR 10

exterior para S 88/1
max. 6 m de largo,
accesorios:
acoplamiento AVR 88
para base regulable
VR 10

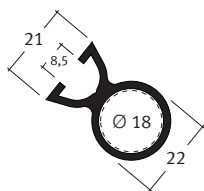
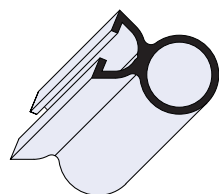

S 88/2

Upright profile Perfil vertical

rotating groove
for S 88/1
max. length 6 m
Accessories:
Insert AVR 88/2
Alu-foot VR 10

interior para S 88/1
max. 6 m de largo,
accesorios:
acoplamiento AVR 88/2
para base regulable
VR 10

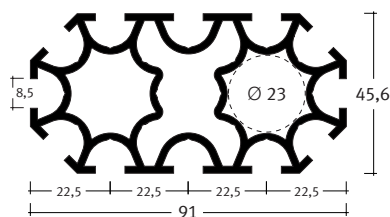
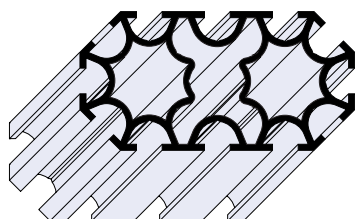

S 81

Upright profile Perfil vertical

max. length 6 m
Accessories:
Insert AVR 81
Alu-foot VR 10
(the adjustable foot
is inserted
into the profile)

max. 6 m de largo,
accesorios:
acoplamiento AVR 81
para base regulable
VR 10

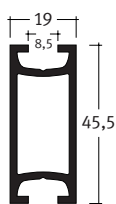
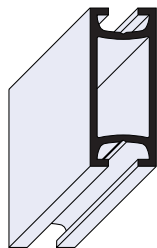

GS 200

Upright profile Perfil vertical

max. length 6 m
Accessories:
Insert AVR 200
Alu-foot VR 10

max. 6 m de largo,
accesorios:
acoplamiento AVR 200
para base regulable
VR 10

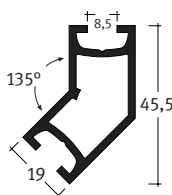
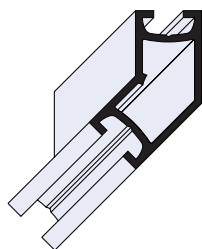

GS 210

Upright profile Perfil vertical

max. length 6 m
Accessories:
Insert AVR 210
Alu-foot VR 10

max. 6 m de largo,
accesorios:
acoplamiento AVR 210
para base regulable
VR 10

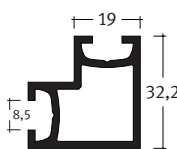
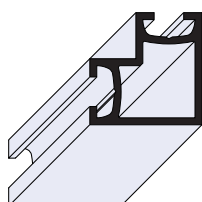

GS 220

Upright profile Perfil vertical

max. length 6 m
Accessories:
Insert AVR 220
Alu-foot VR 10

max. 6 m de largo,
accesorios:
acoplamiento AVR 220
para base regulable
VR 10

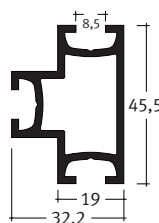
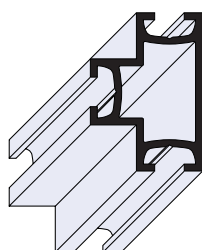

GS 300

Upright profile Perfil vertical

max. length 6 m
Accessories:
Insert AVR 300
Alu-foot VR 10

max. 6 m de largo,
accesorios:
acoplamiento AVR 300
para base regulable
VR 10

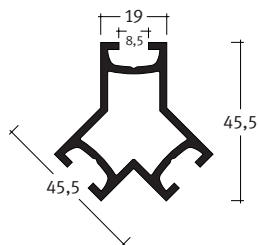
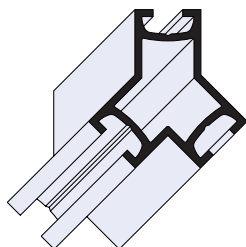

GS 310

Upright profile Perfil vertical

max. length 6 m
Accessories:
Insert AVR 310
Alu-foot VR 10

max. 6 m de largo,
accesorios:
acoplamiento AVR 310
para base regulable
VR 10

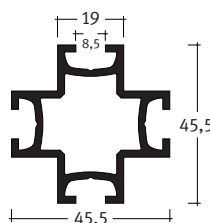
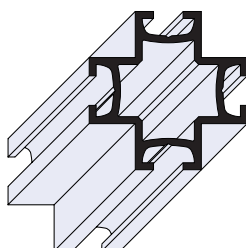

GS 400

Upright profile Perfil vertical

max. length 6 m
Accessories:
Insert AVR 400
Alu-foot VR 10

max. 6 m de largo,
accesorios:
acoplamiento AVR 400
para base regulable
VR 10

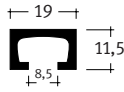
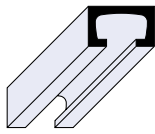

S10

Upright profile Perfil vertical
max. length 6 m max. 6 m de largo

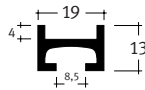
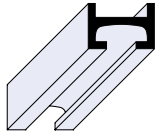

S11

Upright profile Perfil vertical
max. length 6 m max. 6 m de largo

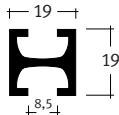
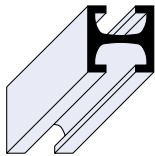

S12

Upright profile Perfil vertical
max. length 6 m max. 6 m de largo

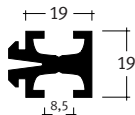
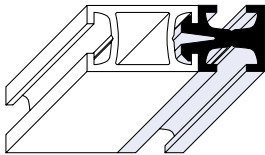

S12/1

Upright profile Perfil vertical
max. length 6 m max. 6 m de largo

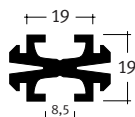
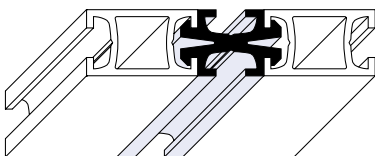

S12/2

Upright profile Perfil vertical
max. length 6 m max. 6 m de largo

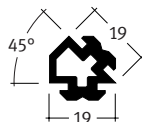
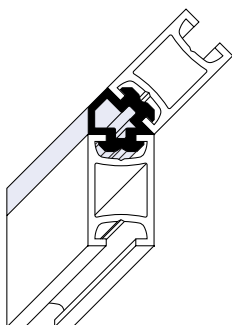

S13

Upright profile Perfil vertical
max. length 6 m max. 6 m de largo

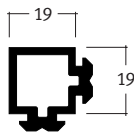
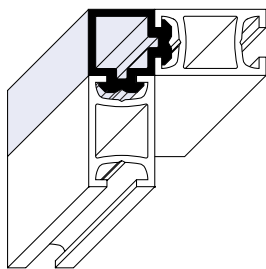

S 14

Upright profile Perfil vertical
max. length 6 m max. 6 m de largo

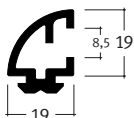
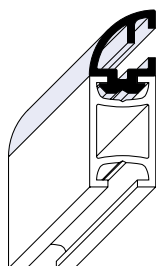

S 15

Upright profile Perfil vertical
max. length 6 m max. 6 m de largo

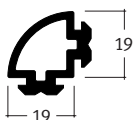
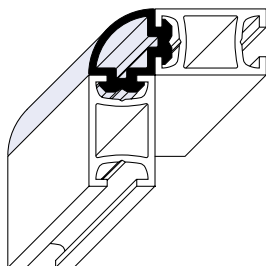

S 16

Upright profile Perfil vertical
max. length 6 m max. 6 m de largo

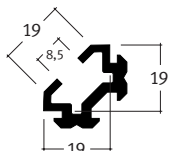
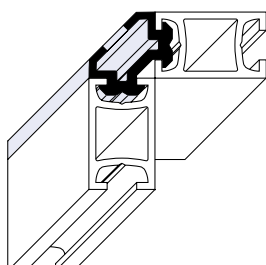

S 17

Upright profile Perfil vertical
max. length 6 m max. 6 m de largo

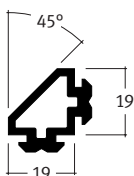
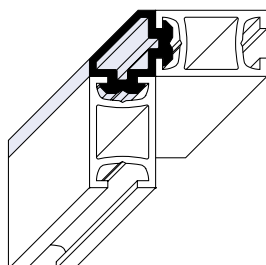

S 18

Upright profile Perfil vertical
max. length 6 m max. 6 m de largo

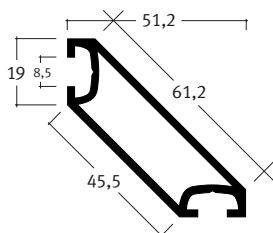
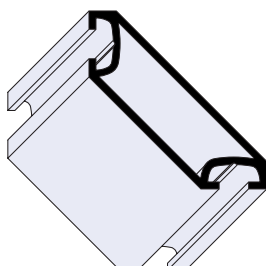

S 23

Upright profile Perfil vertical
max. length 6 m max. 6 m de largo,
accesorios:
acoplamiento AVR 26
para base regulable
VR 8

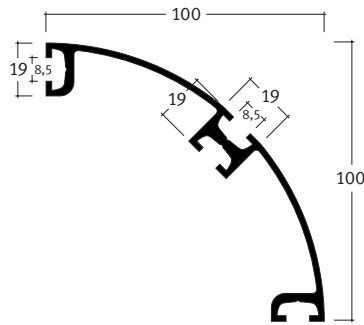
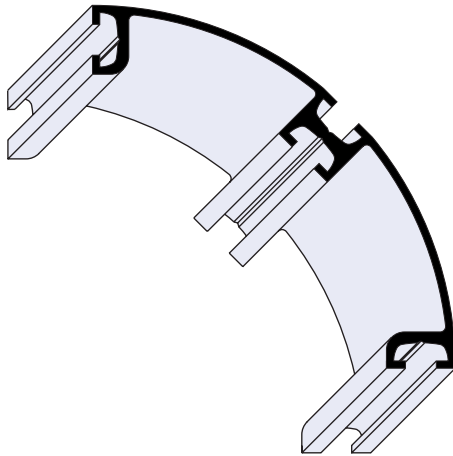

S 19

Upright profile Perfil vertical

max. length 6 m

max. 6 m de largo

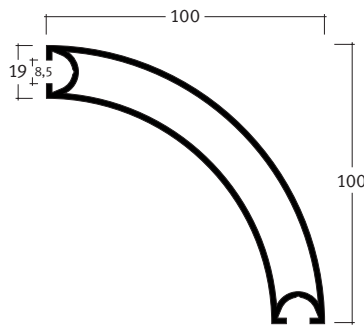
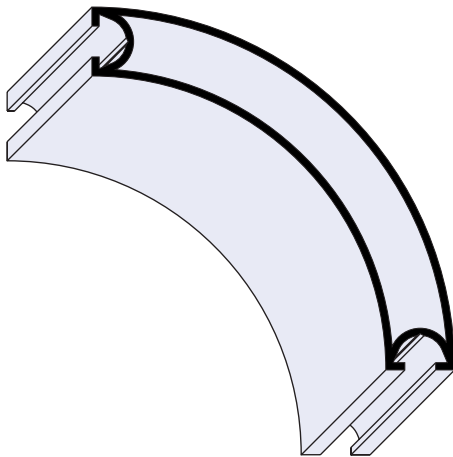

S 20

Upright profile Perfil vertical

max. length 6 m

max. 6 m de largo

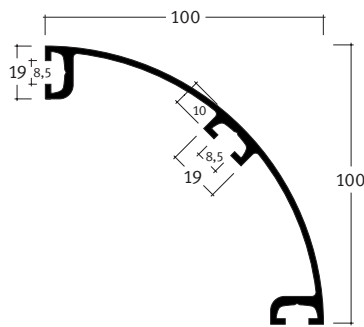
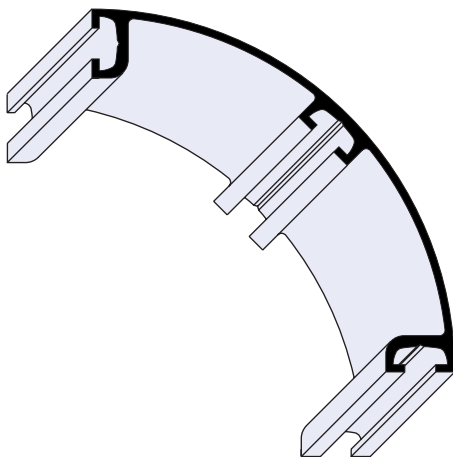

S 21

Upright profile Perfil vertical

max. length 6 m

max. 6 m de largo

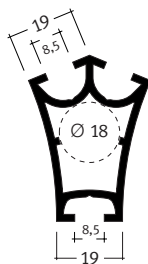
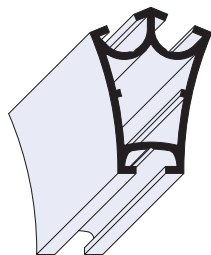

S 24

Upright profile Perfil vertical

max. length 6 m
Accessories:
Insert AVR 24
Alu-foot VR 10

max. 6 m de largo,
accesorios:
acoplamiento AVR 24
para base regulable
VR 10

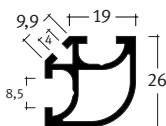
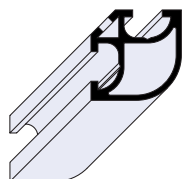

S 26

Upright profile Perfil vertical

max. length 6 m
Accessories:
Insert AVR 26
Alu-foot VR 8

max. 6 m de largo,
accesorios:
acoplamiento AVR 26
para base regulable
VR 8

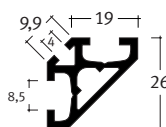
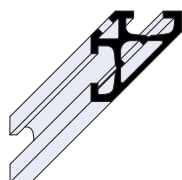

S 27

Upright profile Perfil vertical

max. length 6 m
Accessories:
Alu-foot VR 8

max. 6 m de largo,
accesorios:
acoplamiento VR 8

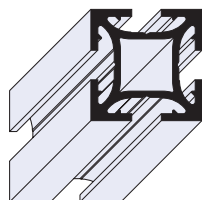

S 40

Upright profile Perfil vertical

max. length 6 m
Accessories:
Insert AVR 40
Alu-foot VR 10
Lock adapter FIX 15

max. 6 m de largo,
accesorios:
acoplamiento AVR 40
para base regulable
VR 10
requiere grapa FIX 15

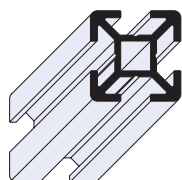

S 41

Upright profile Perfil vertical

max. length 6 m
Accessories:
Insert AVR 41
Alu-foot VR 8

max. 6 m de largo,
accesorios:
acoplamiento AVR 41
para base regulable
VR 8

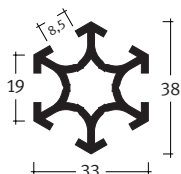
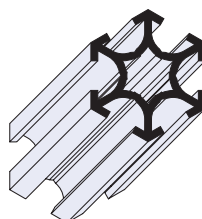

S 61

Upright profile Perfil vertical

max. length 6 m
Accessories:
Insert AVR 61
Alu-foot VR 8

max. 6 m de largo,
accesorios:
acoplamiento AVR 61
para base regulable
VR 8

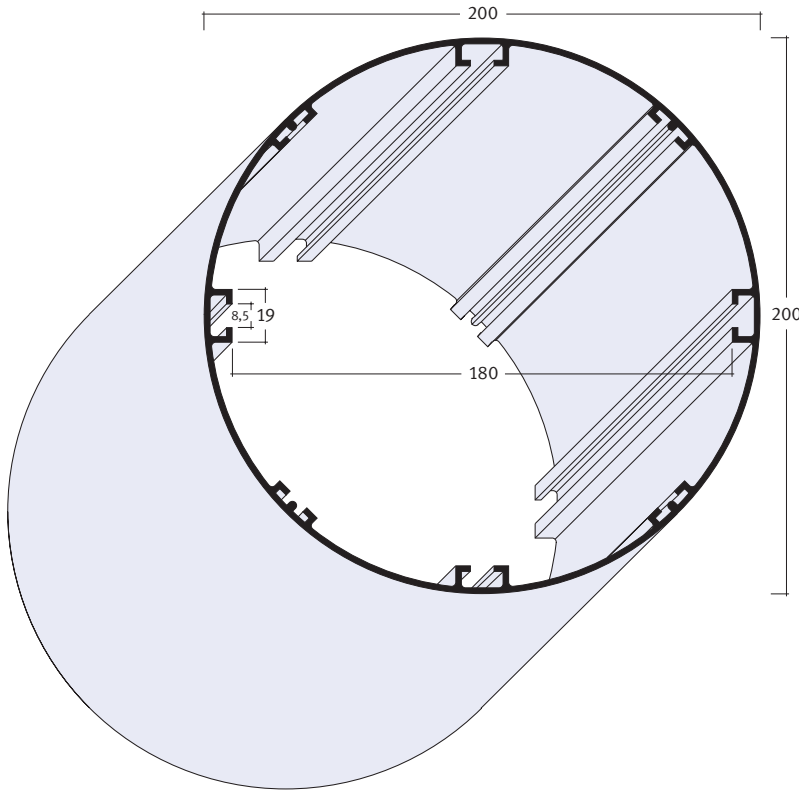

RR 200

Round upright profile

max. length 6 m

Perfil vertical

max. 6 m de largo

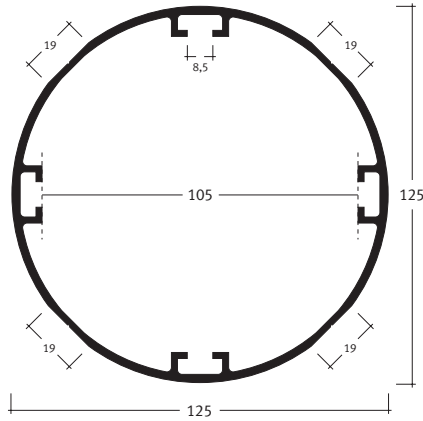
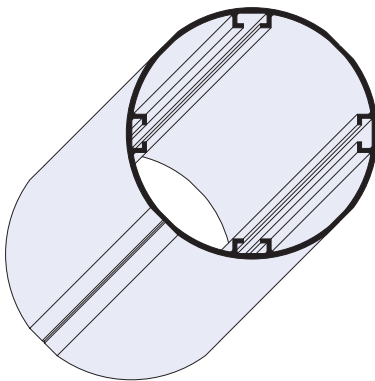

RR 125/4

Round upright profile

max. length 6 m

Perfil vertical

max. 6 m de largo

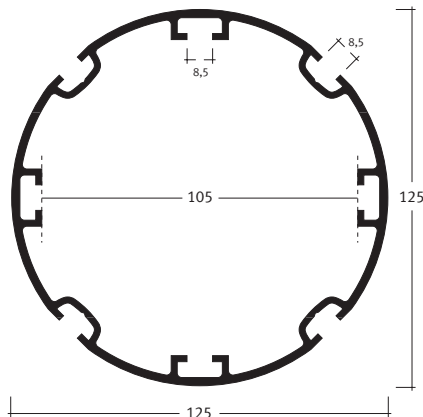
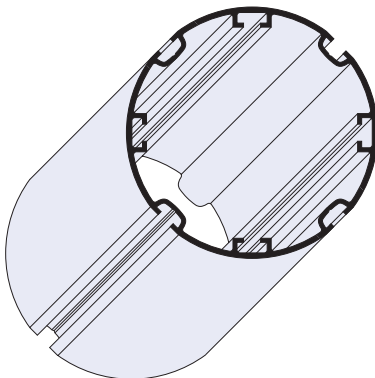

RR 125/8

Round upright profile

max. length 6 m

Perfil vertical

max. 6 m de largo

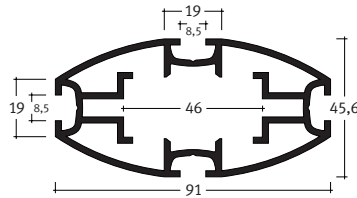
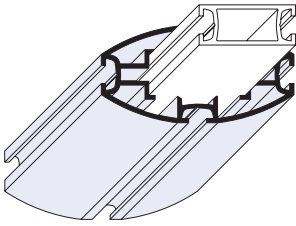

OP 91

Oval profile

Perfil vertical

max. length 6 m
Accessories:
Insert AVR 91
Alu-foot VR 10

max. 6 m de largo,
accesorios:
acoplamiento AVR 91
para base regulable
VR 10

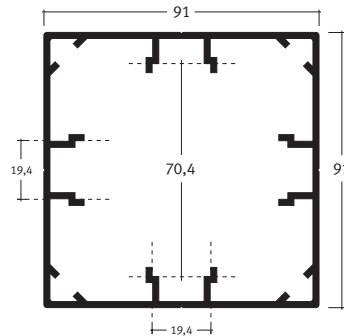
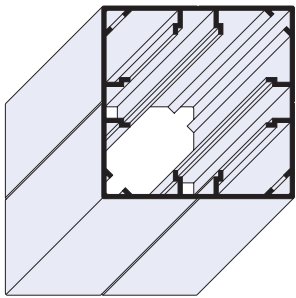

Q 910

Upright profile

Perfil vertical

max. length 6 m

max. 6 m de largo

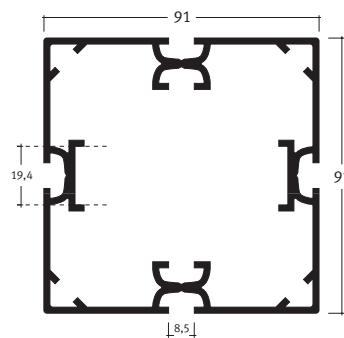
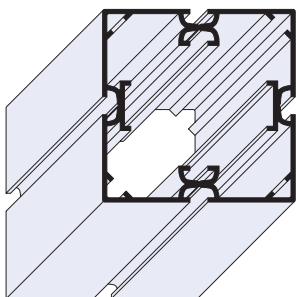

Q 914

Upright profile

Perfil vertical

max. length 6 m

max. 6 m de largo

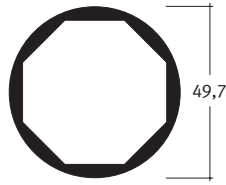
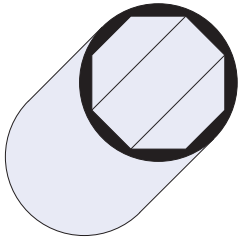

RS 500

Round upright profile Perfil vertical
max. length 6 m max. 6 m de largo

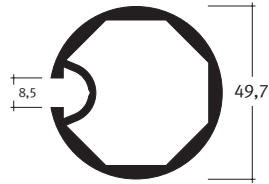
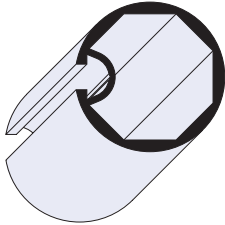

RS 510

Round upright profile Perfil vertical
max. length 6 m max. 6 m de largo

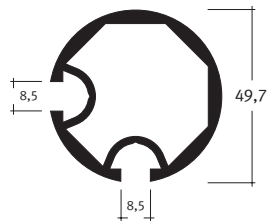
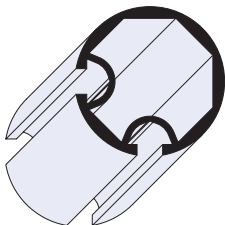

RS 520

Round upright profile Perfil vertical
max. length 6 m max. 6 m de largo

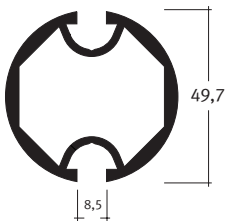
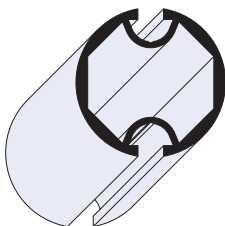

RS 521

Round upright profile Perfil vertical
max. length 6 m max. 6 m de largo

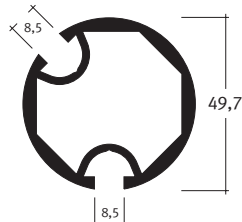
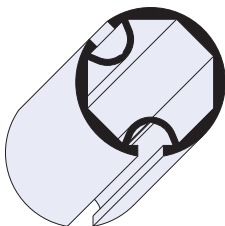

RS 522

Round upright profile Perfil vertical
max. length 6 m max. 6 m de largo

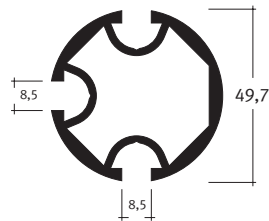
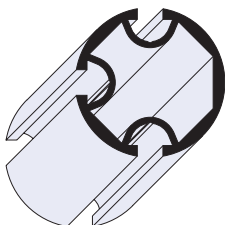

RS 530

Round upright profile Perfil vertical
max. length 6 m max. 6 m de largo

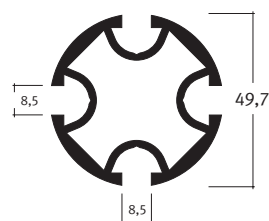
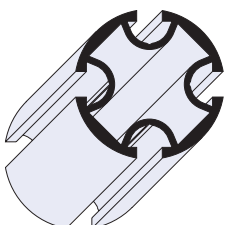

RS 540

Round upright profile Perfil vertical
max. length 6 m max. 6 m de largo

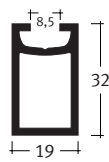
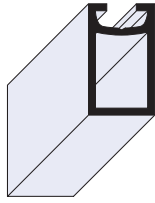

Z 31

Crossbeam profile

max. length 6 m
fitted with FIX 31

Perfil horizontal

max. 6 m de largo,
requiere grapa FIX 31

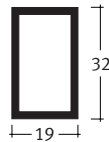
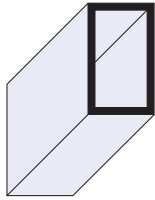

Z 32

Crossbeam profile

max. length 6 m
fitted with FIX 41

Perfil horizontal

max. 6 m de largo,
requiere grapa FIX 41

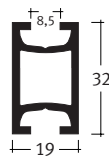
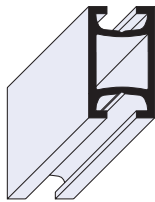

Z 33

Crossbeam profile

max. length 6 m
fitted with FIX 15

Perfil horizontal

max. 6 m de largo,
requiere grapa FIX 15

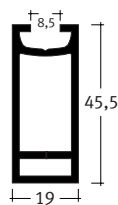
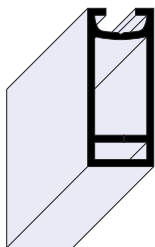

Z 41

Crossbeam profile

max. length 6 m
fitted with FIX 41

Perfil horizontal

max. 6 m de largo,
requiere grapa FIX 41

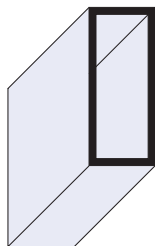

Z 44

Crossbeam profile

max. length 6 m
fitted with FIX 40

Perfil horizontal

max. 6 m de largo,
requiere grapa FIX 40

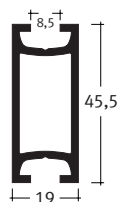
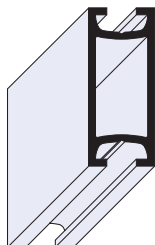

Z 45

Crossbeam profile

max. length 6 m
fitted with FIX 41

Perfil horizontal

max. 6 m de largo,
requiere grapa FIX 41

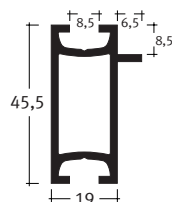
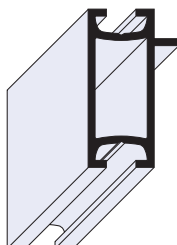

Z 46

Crossbeam profile

length 6 m
fitted with FIX 41

Perfil horizontal

max. 6 m de largo,
requiere grapa FIX 41

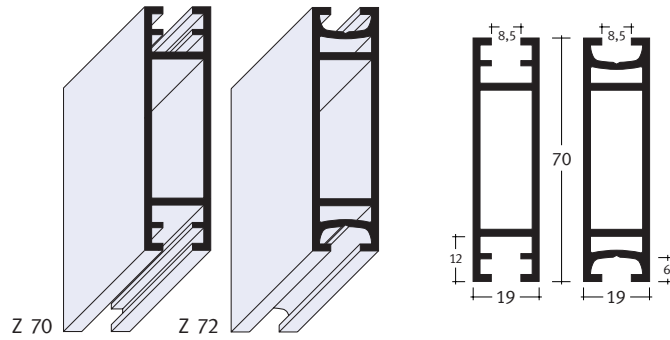

Z 70/72

Crossbeam profile

Z 70: Groove depth 12 mm
Z 72: Groove depth 6 mm
max. length 6 m
require lock FIX 40

Perfil horizontal

Z 70: profundidad de ranura de 12 mm
Z 72: profundidad de ranura de 6 mm
max. 6 m de largo
requieren la grapa FIX 40

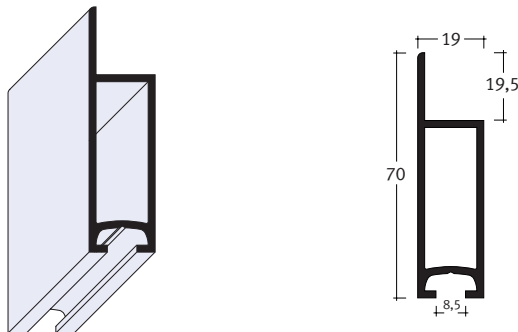

Z 71

Crossbeam profile

max. length 6 m
requires lock FIX 40

Perfil horizontal

max. 6 m de largo
requiere grapa FIX 40

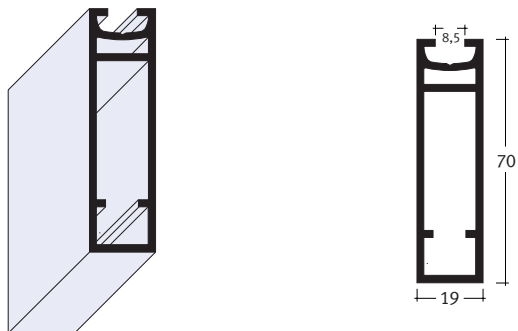

Z 75

Crossbeam profile

Groove depth 6 mm
max. length 6 m
requires lock FIX 40

Perfil horizontal

profundidad de ranura de 6 mm
max. 6 m de largo
requiere grapa FIX 40

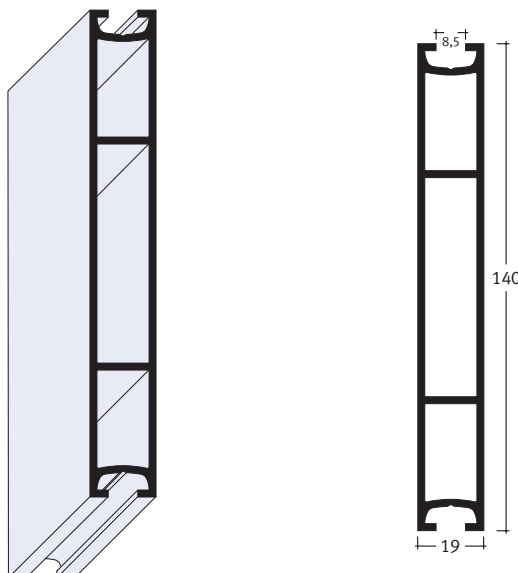

Z 140

Crossbeam profile

max. length 6 m
requires
4x lock FIX 41

Perfil horizontal

max. 6 m de largo
requiere
4 x grapa FIX 41

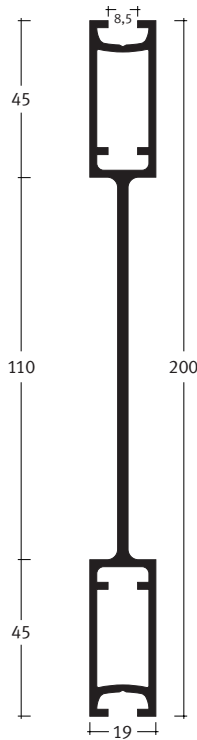
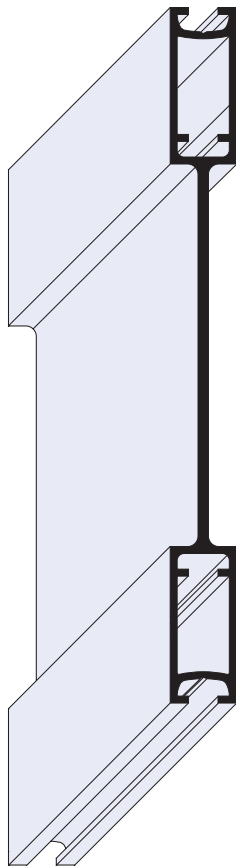

Z 245

Crossbeam profile

max. length 6 m
requires
4x lock FIX 41

Perfil horizontal

max. 6 m de largo,
requiere
4 grapas FIX 41

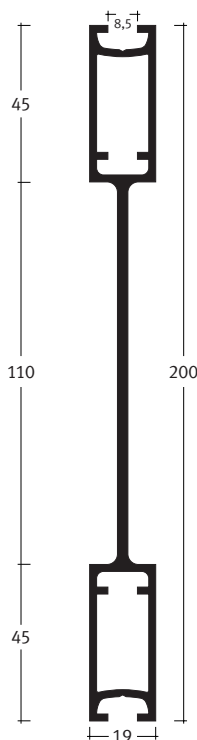
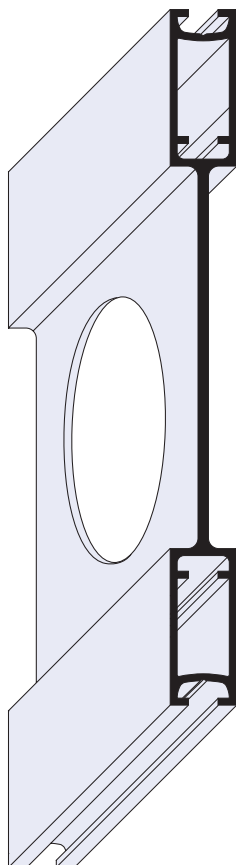

Z 245 RL

Crossbeam profile

Space-Line
max. length 6 m
requires
4x lock FIX 41

Perfil horizontal

con perforación
redonda
max. 6 m de largo,
requiere
4 grapas FIX 41

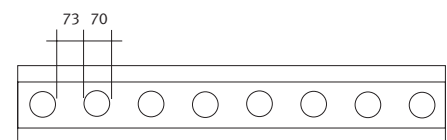

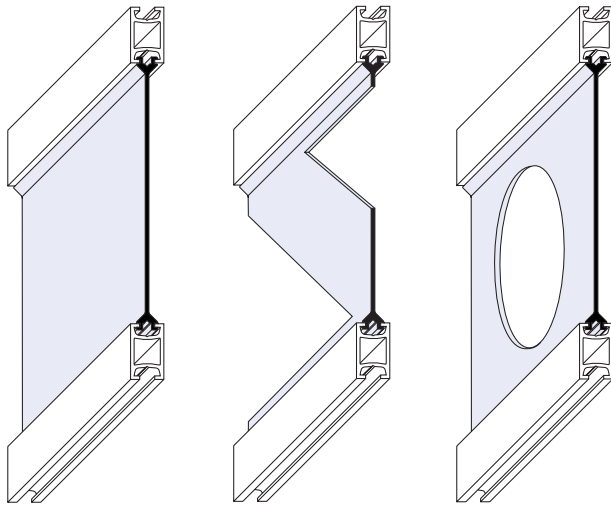

The basis of the MODUL „Space-Line“ are the aluminium trims which can be slipped into the grooves of all standard upright and crossbeam profiles.

La gama MODUL „Space-Line“ esta compuesta por: una cartela de aluminio que se desliza por los perfiles verticales y horizontales.

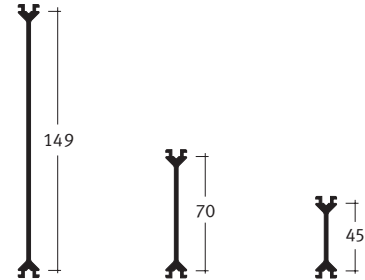

PR 80/149

Aluminium trim
max. length 6 m

Cartela de aluminio
max. 6 m de largo

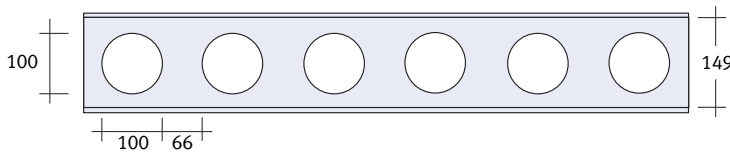

PR 81/149

Aluminium trim
max. length 6 m

Cartela de aluminio
max. 6 m de largo

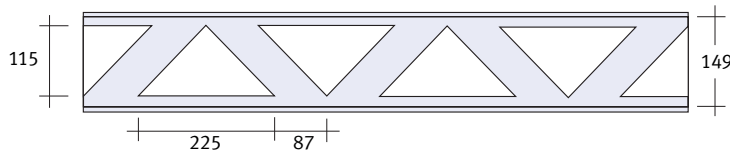

PR 82/149

Aluminium trim
max. length 6 m

Cartela de aluminio
max. 6 m de largo

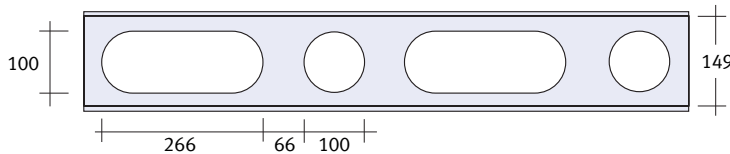

PR 85/149

Aluminium trim
max. length 6 m

Cartela de aluminio
max. 6 m de largo

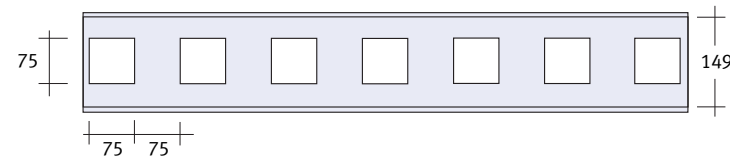

PR 86/149

Aluminium trim
max. length 6 m

Cartela de aluminio
max. 6 m de largo

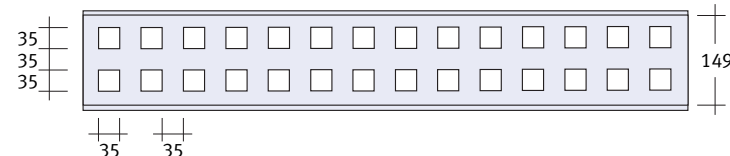

PR 87/149

Aluminium trim
max. length 6 m

Cartela de aluminio
max. 6 m de largo



PR 80/70

Aluminium trim
max. length 6 m

Cartela de aluminio
max. 6 m de largo

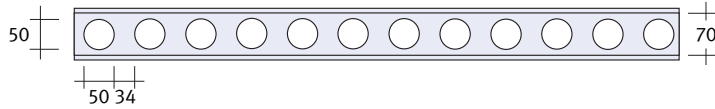

PR 81/70

Aluminium trim
max. length 6 m

Cartela de aluminio
max. 6 m de largo

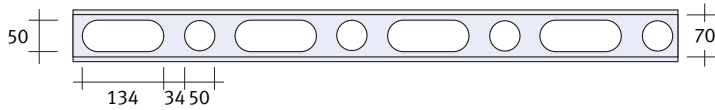

PR 85/70

Aluminium trim
max. length 6 m

Cartela de aluminio
max. 6 m de largo

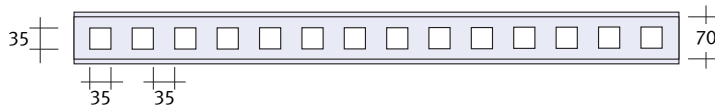

PR 86/70

Aluminium trim
max. length 6 m

Cartela de aluminio
max. 6 m de largo



PR 80/45

Aluminium trim
max. length 6 m

Cartela de aluminio
max. 6 m de largo

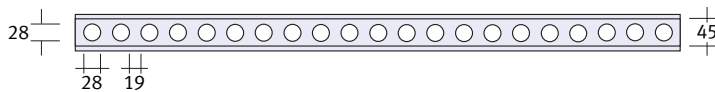

PR 81/45

Aluminium trim
max. length 6 m

Cartela de aluminio
max. 6 m de largo

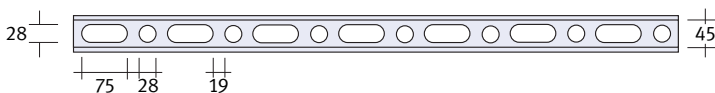

PR 85/45

Aluminium trim
max. length 6 m

Cartela de aluminio
max. 6 m de largo

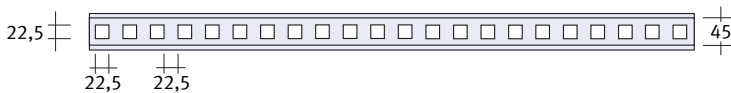

PR 86/45

Aluminium trim
max. length 6 m

Cartela de aluminio
max. 6 m de largo

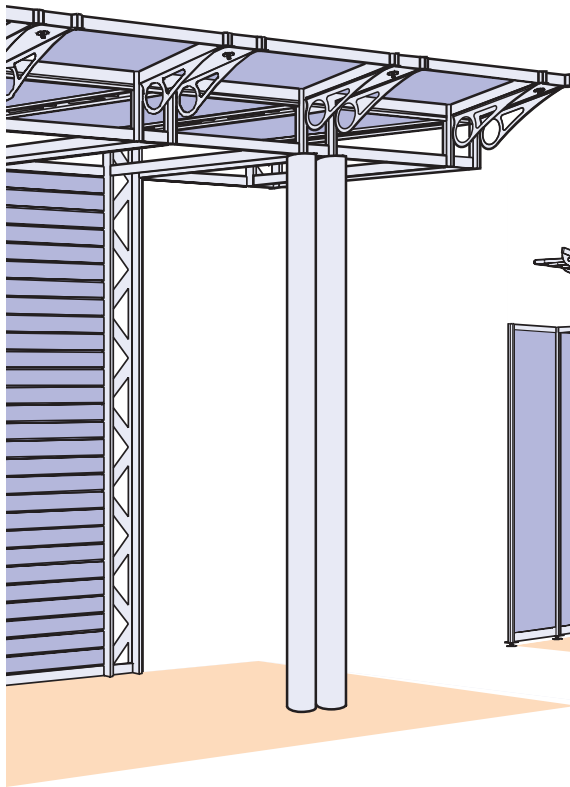

The Space-Line accessories are manufactured from the PR 80/149 and PR 80/70 profile range. Their function is to enhance the Space-Line range and to accommodate a variety of aluminium tubes.

Los accesorios Space-Line se fabrican a partir de los perfiles PR 80/149 y PR 80/70. Forman una aplicación de la gama Space-Line y permiten la unión con perfiles redondos.

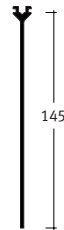
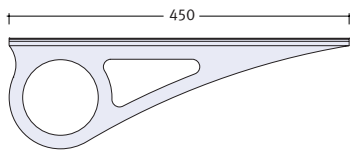
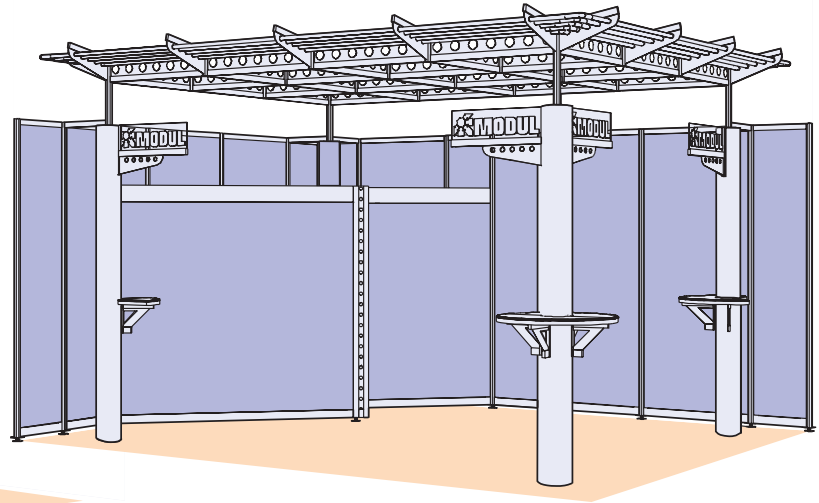

SL 20

Space-Line

Deko accessory
manufactured
from PR 80/149

Space-Line

elemento deco
se fabrica a partir
de PR 80/149

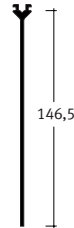
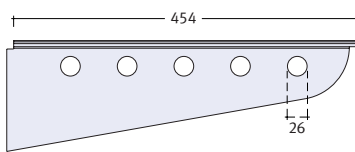

SL 21

Space-Line

Deko accessory
manufactured
from PR 80/149

Space-Line

elemento deco
se fabrica a partir
de PR 80/149

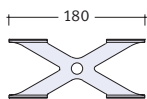

SL 22

Space-Line

Deko accessory
manufactured
from PR 80/70

Space-Line

elemento deco
se fabrica a partir
de PR 80/70

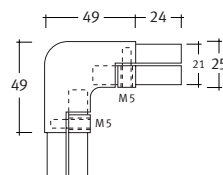
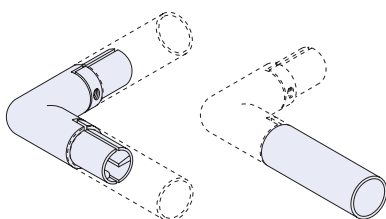

RRV 25 M

Connector
90°

Unión de
esquina 90°

RR 25

Tube
round
max. length 6 m

Tubo redondo
max. 6 m de largo

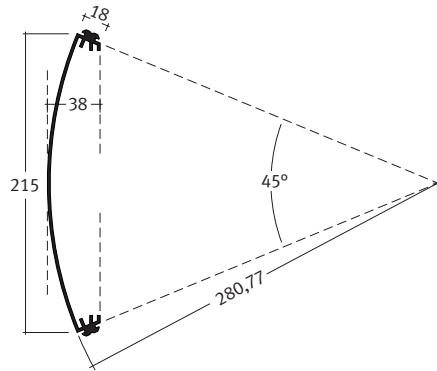
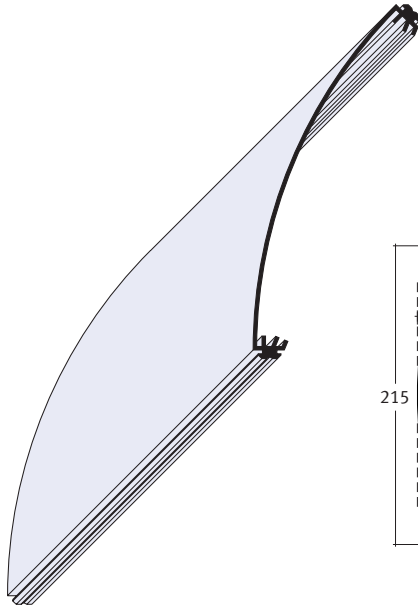

PR 90

Connecting profile

max. length 6 m

Perfil de union

max. 6 m de largo

Bajo consulta se pueden realizar cortes especiales

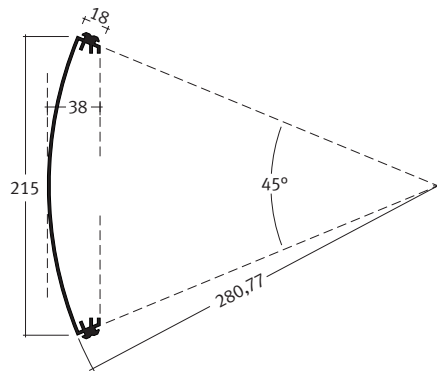
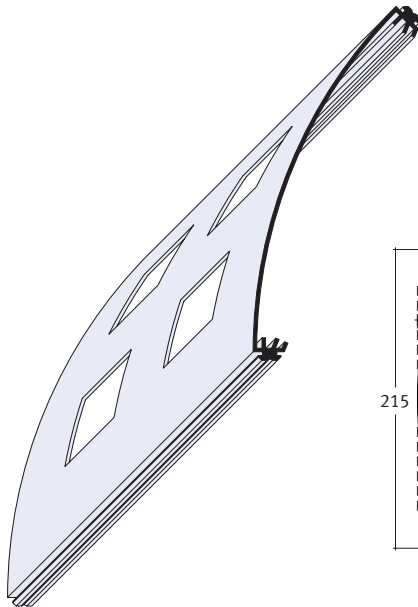

PR 91

Connecting profile

square holes 40 x 40 mm, horizontal hole distance 40 mm, vertical hole distance 40 mm, max. length 6 m

Perfil de union

con perforaciones cuadradas de 40 x 40 mm
Distancia entre perforaciones horizontales: 40 mm
Distancia entre perforaciones verticales: 40 mm
max. 6 m de largo

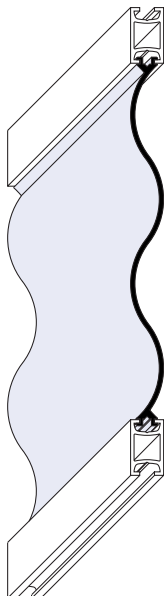

PR 98

Connecting profile

max. length 6 m

Perfil de union

max. 6 m de largo

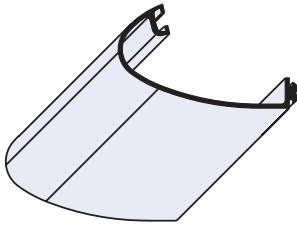

PR 94

Connecting profile
max. length 6 m

Perfil de union
max. 6 m de largo

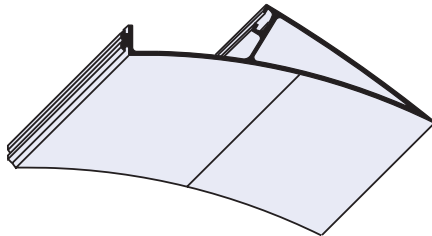

PR 95

Connecting profile
max. length 6 m

Perfil de union
max. 6 m de largo

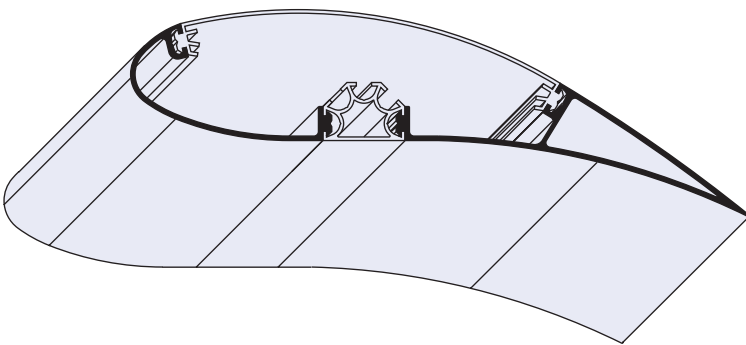

Fin component
consisting of:

Configuración tipo ala
compuesta por perfiles de union:

PR 90

+

PR 94

+

PR 95

Connecting profiles

Example combines upright profile S 50
Other profiles with the axial measurements of 45,6 mm can also be used
max. length 6 m

Perfiles de union

combinado con un perfil vertical estándar S50
Se pueden utilizar otros perfiles verticales con un diametro de 45,6 mm
max. 6 m de largo

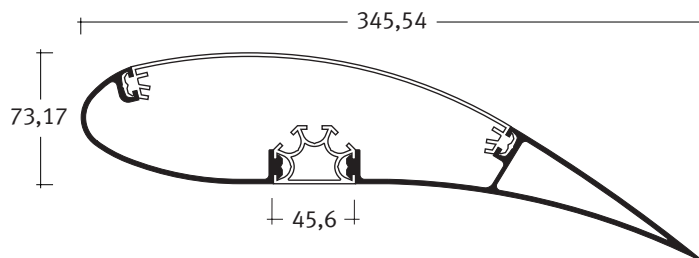

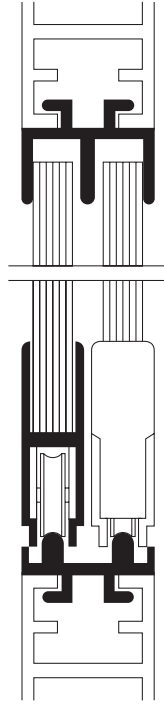
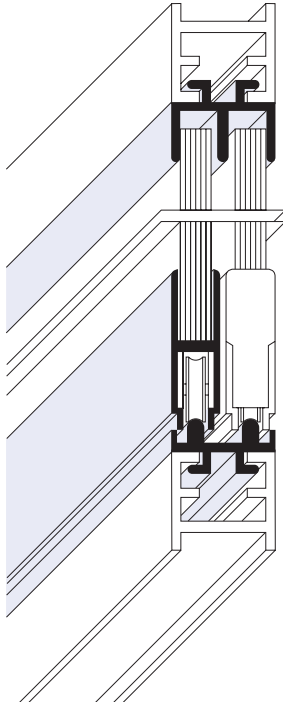

PR 20/K

Sliding door profile

complete unit for one pair of sliding doors
max. length 6 m

Supplement:
Safety lock ZU 15 B

Perfiles para puerta corredera

completa con rueda
max. 6 m de largo

accesorio:
cerradura tipo
ZU 15 B

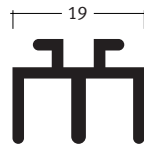
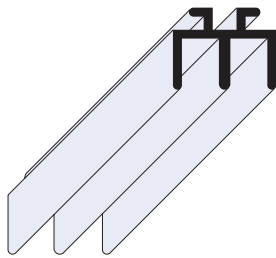

11

PR 20/1

Sliding door profile top

max. length 6 m

Perfil superior

max. 6 m de largo

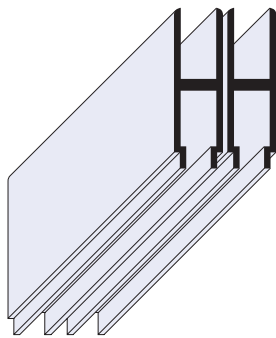

29,5

PR 20/2

Insert profile aluminium

max. length 6 m

Glass or wood panels can be mounted

Junquillo aluminio

max. 6 m de largo

sirve para paneles de madera o de cristal

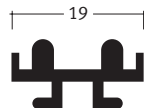
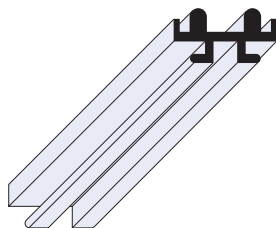

6

PR 20/3

Sliding door profile bottom

max. length 6 m

Perfil inferior

max. 6 m de largo

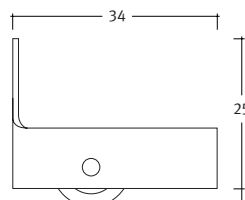
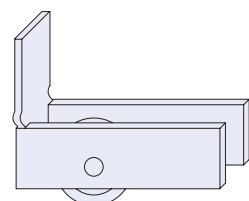

PR 20/4

Roller

with endpiece

Rueda

con tope para puertas correderas

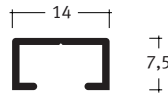
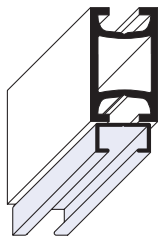

PR 27

Curtain rail

Perfil para
cortina

max. length 5 m

max. 5 m de largo

Standard curtain requires:
20 x T 3/1 curtain hooks
1 x T 3/2 end piece
4 x V 6 back plates

Para medida estándar de
1000 mm se necesitan los
elementos siguientes para
el montaje de la cortina:
20x T3/1 gancho de cortina
1x T3/2 tapa final
4x V6 pieza de fijación

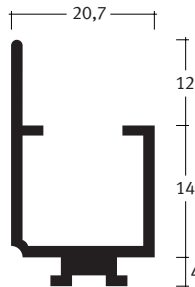
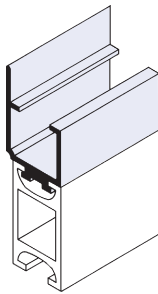

PR 29

Aluminium
door stop

Tope de
puerta

max. length 4,10 m
for standard-
doors 2 m

max. 4,10 m de largo
para puertas
estándar 2 m

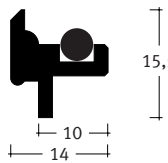
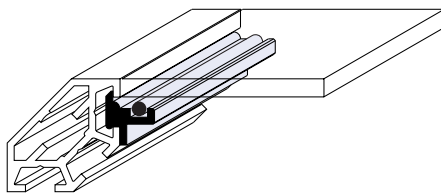

PR 30

Glass frame
profile

Perfil soporte
baldas

for 6 mm glass
with rubber bumper
max. length 5 m

para cristal de 6 mm
con junta de goma
hasta max. 5 m
de largo

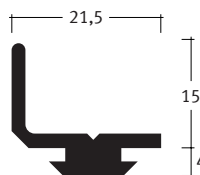
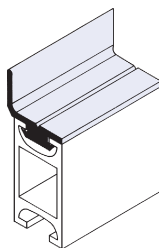

PR 37

Aluminium
stopper

Tope de
aluminio

max. length 6 m

max. 6 m de largo

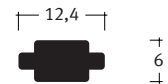
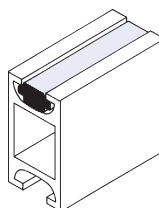

PR 38

Aluminium
groove filler

Perfil de
remate

max. length 6 m

max. 6 m de largo

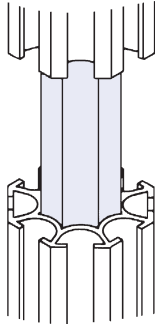

PR 39

Aluminium
core

for S 80
max. length 3 m

Pieza
de empalme

para S 80
aluminio,
max. 3 m de largo

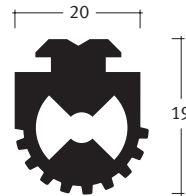
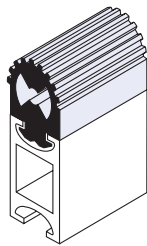

PR 41

Hinge groove
profile

max. length 6 m

Perfil
de bisagra

max. 6 m de largo

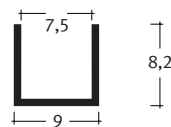
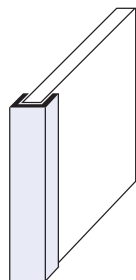

PR 43

U-profile

edging
max. length 2 m

Perfil de
remate en U

max. 2 m de largo

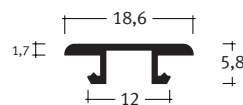
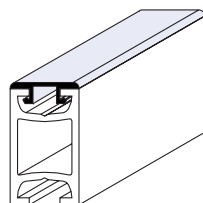

PR 44

Aluminium
covering strip

max. length 6 m

Perfil de
remate

max. 6 m de largo

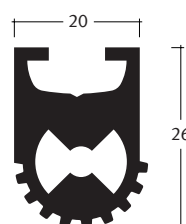
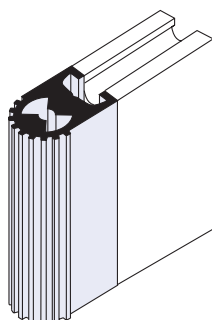

PR 46

Hinge profile
FIX connection

max. length 6 m

Perfil
de bisagra

max. 6 m de largo

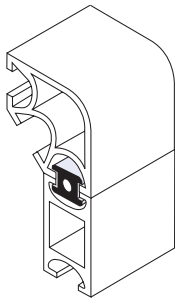

PR 47

H-profile
max. length 6 m

Perfil de unión en H
max. 6 m de largo

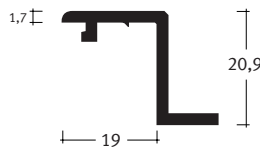
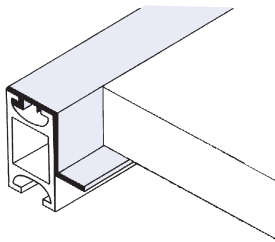

PR 48

Single support
max. length 6 m

Soporte simple
max. 6 m de largo

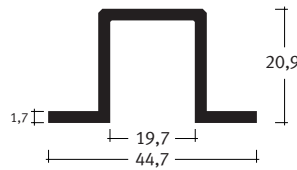
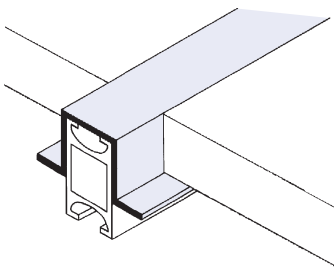

PR 49

Double support
max. length 6 m

Soporte doble
max. 6 m de largo

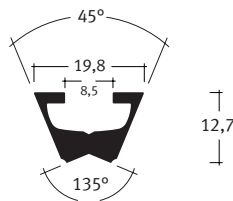
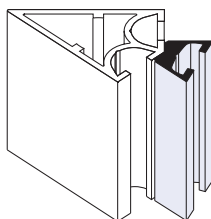

PR 50

Additional groove for S 22
max. length 6 m

Ranura adicional para S 22
max. 6 m de largo

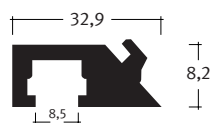
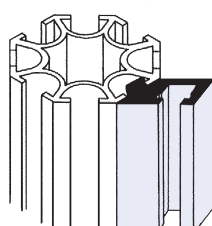

PR 51

Additional groove
max. length 6 m

Ranura adicional
max. 6 m de largo

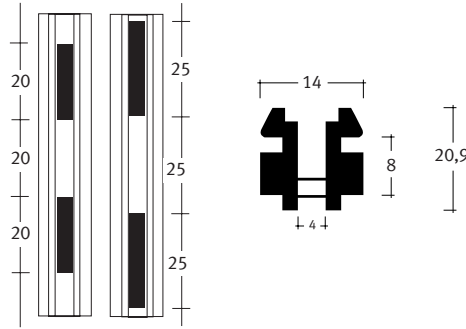
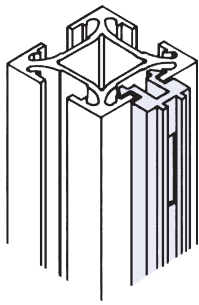

PR 55/20

Slot rail
20 mm pitch
max. length 6 m

Perfil trocelado
distancia de 20 mm
max. 6 m de largo

PR 55/25

Slot rail
25 mm pitch
max. length 6 m

Perfil trocelado
distancia de 25 mm
max. 6 m de largo

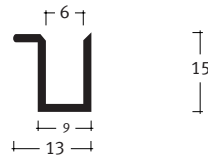
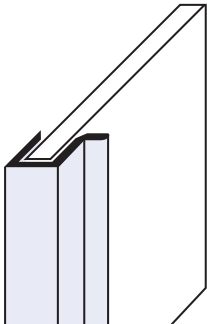

PR 60

Sliding door
handle
max. length 6 m

Perfil para el
deslizamiento
en puerta corredera
max. 6 m de largo

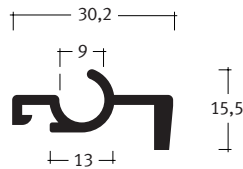
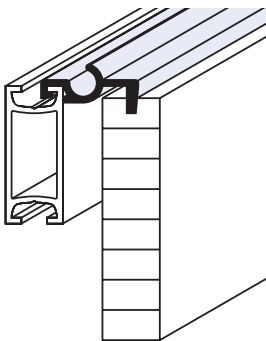

PR 70

Top panel
clip top
max. length 3 m

Perfil superior
para revestimiento de
paredes
max. 3 m de largo

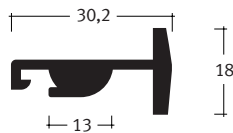
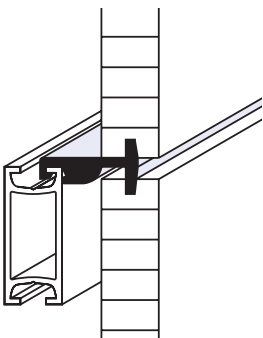

PR 71

Center panel
clip middle
max. length 3 m

Perfil intermedio
para revestimiento de
paredes
max. 3 m de largo

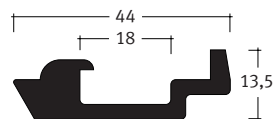
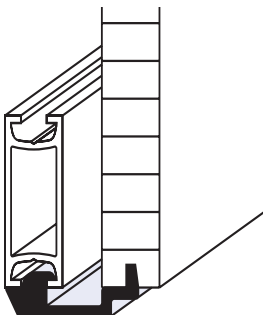

PR 72

Bottom panel
clip bottom
max. length 3 m

Perfil inferior
para revestimiento de
paredes
max. 3 m de largo